

INNOVATIONS 2026



PLAY OF COLOURS IN ACRYLIC



METURO PROGRAMME
— ACRYLIC IN A METALLIC LOOK



VM 075v satin platinum

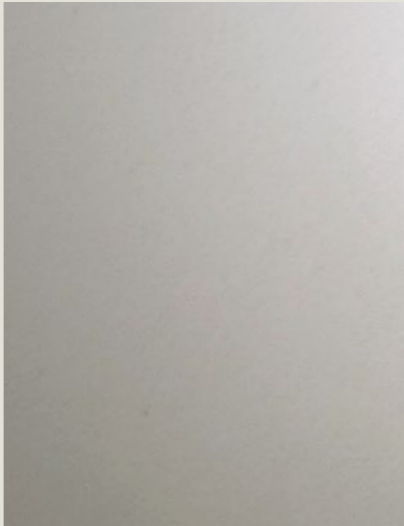

VM 076v satin copper



VM 077v satin graphite



WAKUU PROGRAMME
— CLEARLY SHAPED



COLOURS

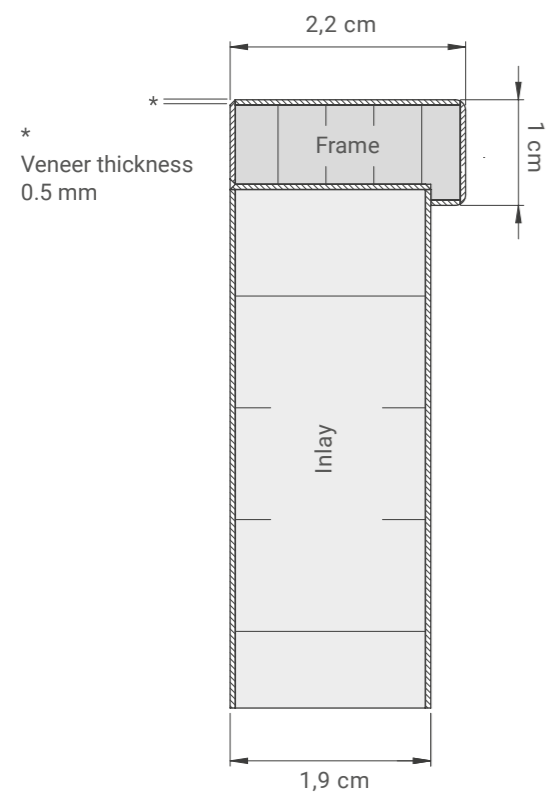

WAKUU-FS PROGRAMME



AMETIS PROGRAMME

– METALLIC LACQUER FOR SPATIAL EFFECT



ME 163 cuprum

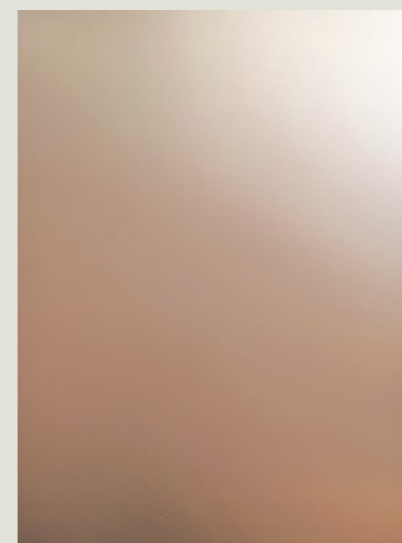

ME 164 auren



ME 165 feron



ME 166 tanor



BOSSA-FS PROGRAMME

COLOURS





HYGGE COLOUR CONCEPT – FOR SELECTED LACQUER PROGRAMMES

RAL 250 80 10 light cyan

RAL 090 90 30 wax yellow



RAL 120 70 10 Nile green



RAL 060 60 10 oak brown



RAL 010 80 10 mud pink



RAL 070 80 10 flax beige

NEW COLOURS AND DECORS



CURVED SIDE PANEL CONCEPT



ALL-ROUND STYLISH PLANNING



WFI 5R (R = 5 cm)



WFI 15R (R = 15 cm)



Design lines:

Programmes:

Panel thickness:

Radius:

PLANNING SUGGESTION:

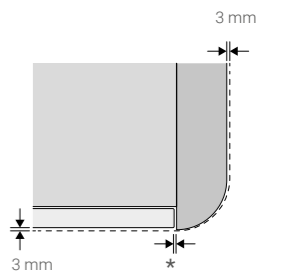

For radius processing on worktops, finishing tops and table tops, we recommend a radius equal to the side panel thickness plus the front overhang. For a uniform appearance, the side overhang and the overhang of the worktop at the front should be planned to be identical.

KYOTO PLANNING CONCEPT — ADDITIONAL COLOURS AND HANDLES



Also new: the KYOTO programme approvals for plain colours have been extended! Can now also be planned with the programmes:

216 IDEA
231 AMETIS
238 METURO

Discover the next level of minimalist interior design with KYOTO – inspired by Japanese craftsmanship and realised with state-of-the-art precision.



PLANNING TIPS AND ORDERING

HANDLES

661.319
alpine natural oak

661.320
walnut natural

662.405*
stainless steel

663.xxx colour*:
20 powder colours,
15 Les Couleurs® Le
Corbusier® colour collection

PROGRAMMES PLAIN COLOURS

233 CERES
215 SIRIUS
255 MIRO
239 BONDI
238 METURO*
212 CLASSIC-FF
254 TOCCO
216 IDEA*
253 F 45
240 PEARL
213 CLASSIC-FS
231 AMETIS*
288 LARGO-FG

PROGRAMMES DECORS

224 GEO
217 TERRA
221 IKONO
222 SYNTHIA
219 ORLANDO
241 MINERA
269 TOPOS
210 LAIKA
276 TERMA
293 CONCRETE
291 STEEL
284 ALURO

THE FOLLOWING PROGRAM- MES ARE EXCLUDED:

AVENIDA, CARRÉ-FS,
VERVE-FS, WAKUU /
WAKUU-FS, BOSSA /
BOSSA-FS, BAHIA,
IOS / IOS-M, KERA,
ROCCA, Q Programme

SIDE PANELS AND SHELVES W2, B2

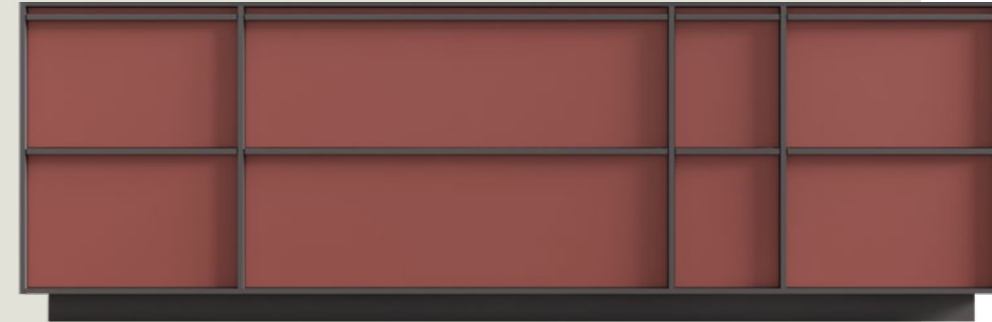

SAMPLE PLAN 1:

Front:
IDEA 173 crimson

Side panels:
CLASSIC-FF 284 carbon grey

Handle:
663.284 carbon grey (powdered)

Plinth:
CLASSIC-FF 284 carbon grey

Worktop:
Glass 284 carbon grey

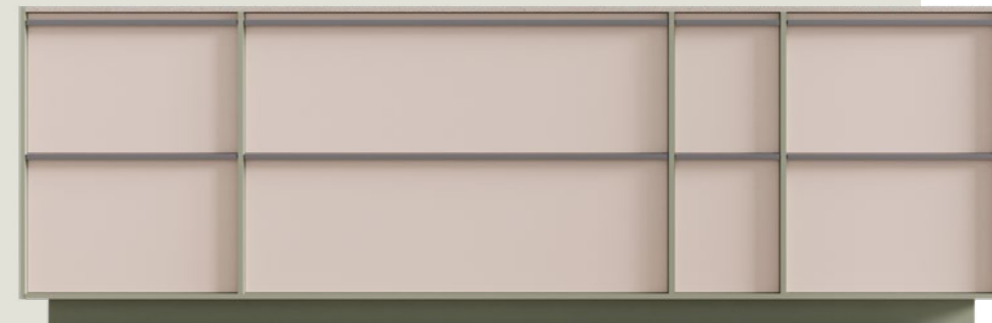

SAMPLE PLAN 2:

Front:
CLASSIC-FS
RAL 070 80 10 flax beige

Side panels:
CLASSIC-FS
RAL 120 70 10 Nile green

Handle:
663.013 gris foncé 31
(Les Couleurs® Le Corbusier®)

Plinth:
CLASSIC-FS
RAL 120 70 10 Nile green

Worktop:
Laminate worktop 289 dolomita

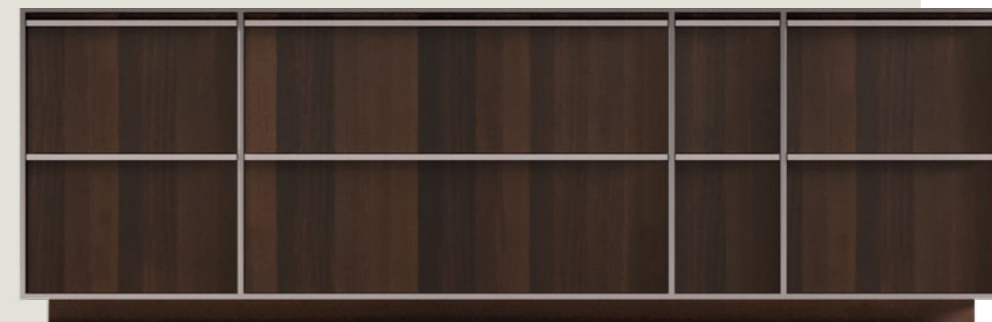

SAMPLE PLAN 3:

Front:
TERMA 360 maraval chestnut

Panels:
METURO 075 satin platinum

Handle:
662.405 stainless steel

Plinth:
TERMA 360 maraval chestnut

Worktop:
472 acciaio inox

*New in the KYOTO planning concept

PULLOUT UTILITY UNIT



Pullout utility unit with set 2
HAA 20 204 ZR
HAA SET 2



Pullout utility unit with set 3
HAA 15 204 ZR
HAA SET3

PRODUCT INFORMATION:

- Can be integrated into the PRIMO and CONTINO design lines (vertical recessed handle only)
- For unit depths 58 and 68 cm
- Interior style: 273 platinum and 284 carbon grey
- Right-hand version: accessible from the left-hand side
- Left-hand version: accessible from the right-hand side
- Handle-less design for a continuous front appearance
- Maximum payload 70 kg
- Inner pullout with 1.6 cm thick back panel
- Basic pullout unit: empty
- Adjustable in width

EXCLUSIONS:

PANTRY

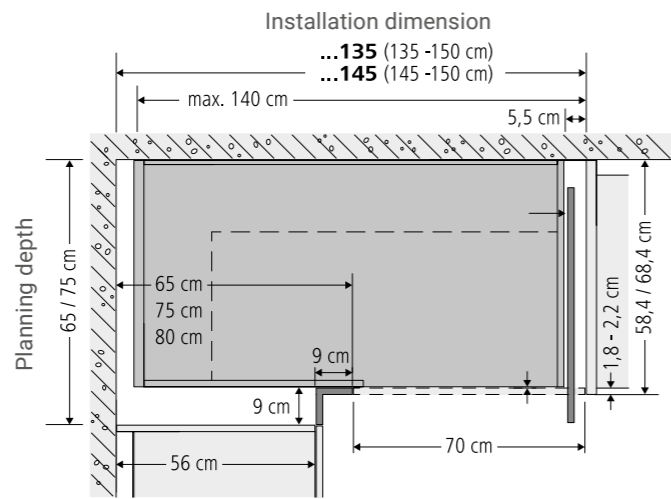
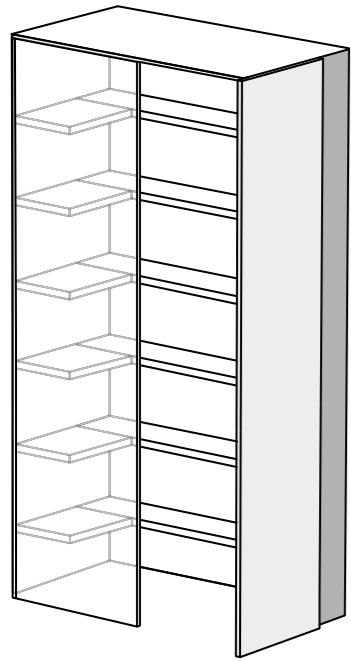

44



LIFT TRAY FOR UNITS AND SIDE PANELS

LIFT TRAY FOR UNITS:

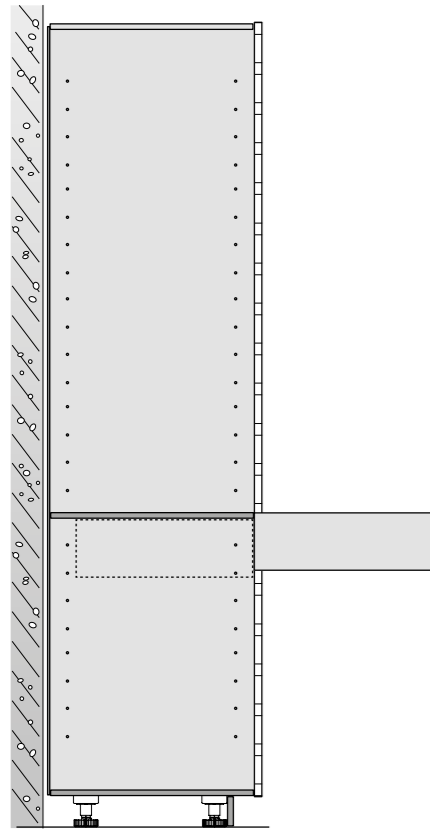

Lift tray for tall unit
(HTAL...)

Note: Wide angle hinges necessary
for units

USE OF LIFT TRAYS:

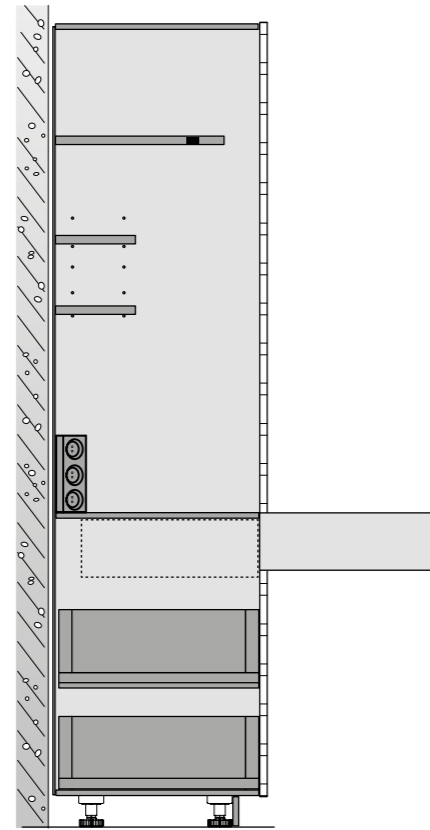

Lift tray instead of pullout tray
(ANTALVF)

for breakfast tall unit



LIFT TRAY FOR UNITS AND SIDE PANELS

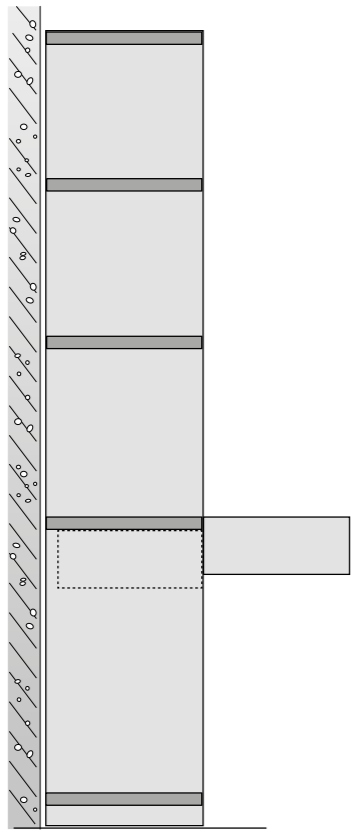

Lift tray for W3 side panel shelf unit –
(B3WTAL...48)
flush finish with 2.8 cm shelf



ALL-ROUND RECESSED HANDLE



SPECIAL FEATURES / NOTES

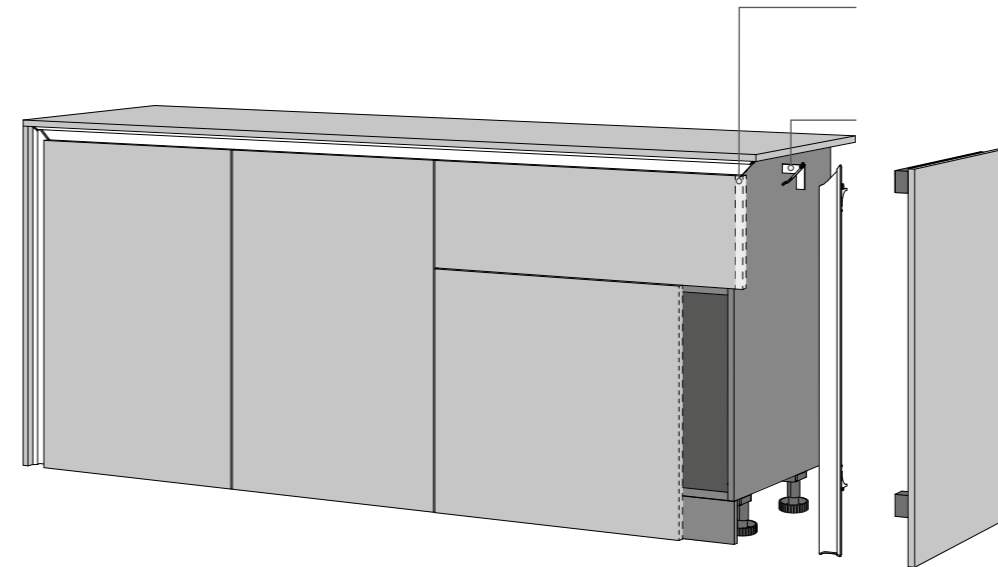

Detailed view:

Standard recessed handle length:

Recessed handle ends with lower edge of unit, including end caps

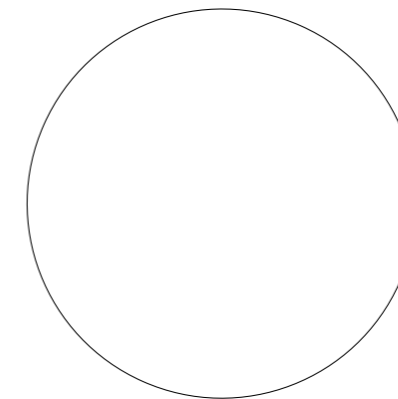
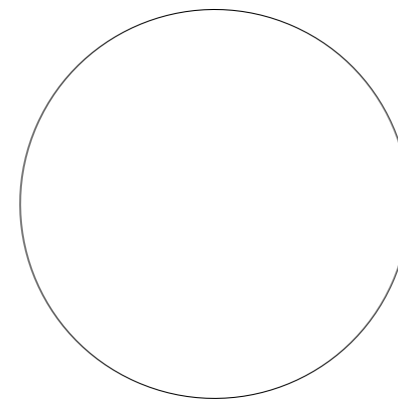
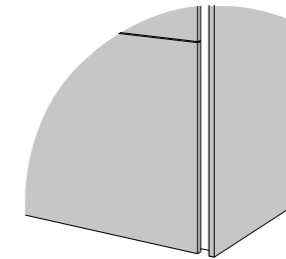
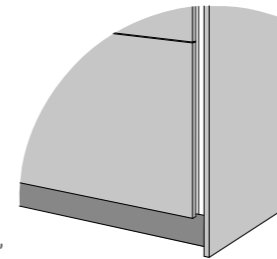

Recessed handle length with front extension:

Recessed handle, to the floor, incl. end caps; plinth flush with carcass

PLINTH STEP | PLINTH DRAWER

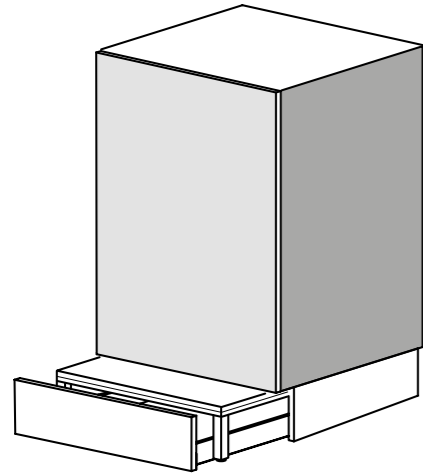

PULLOUT PLINTH STEP WITH PLINTH DRAWER

Plinth step – a clever solution. In compact kitchens, every centimetre counts: the innovative plinth step transforms the furniture plinth into a practical platform – ideal for children and anyone who wants to reach higher work areas or wall units more easily. Available in **widths from 60 cm to 90 cm** and with an additional plinth drawer for extra storage space. Functional, ergonomic and space-saving.

PRODUCT INFORMATION:

- Cupboard designed for pullout plinth step with plinth drawer: AN SKST
- Plinth level in 273 platinum and 284 carbon grey
- SKST...58
- SKST...68
- SKST...58 TISO
- SKST...68 TISO
- Step depth: 30 cm
- Handle 564.405 / Tip-Softclose
- Approval: under floor and tall units - plinth drawer 15.0 cm
- Maximum permissible weight: 150 kg

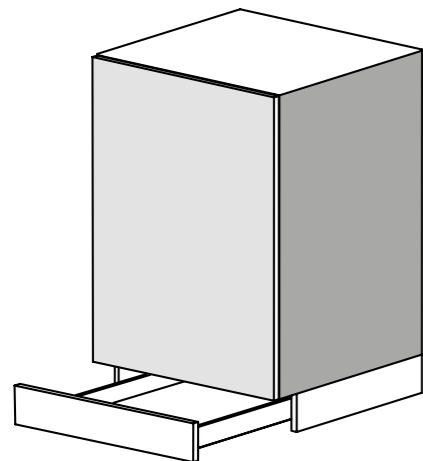

PRACTICAL PLINTH DRAWER – MORE STORAGE SPACE USED CLEVERLY

More space where you least expect it: the plinth drawer makes optimal use of the space between the plinth legs and creates additional storage space directly in the plinth area. The practical solution is positioned between the plinth legs and blends seamlessly into the plinth cover.

PRODUCT INFORMATION:

- Cupboard designed for plinth drawer: AN SK
- SK...58
- SK...68
- SK...58 TISO
- SK...68 TISO
- Pullout depth: 40 to 50 cm
- Plinth height: 13.5 to 17.5 cm
- Suitable for unit depths: 58 cm and 68 cm
- Handle 564.405 / Tip-Softclose

VERO INTERMEDIATE DIMENSIONS

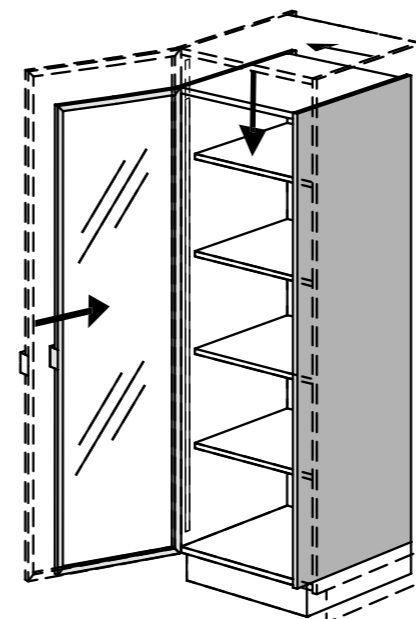

CONVENIENCE MEETS FUNCTIONALITY

Our VERO glass display cabinets, which are compatible with all our programmes, now offer even more design freedom. They are available in customised sizes with widths accurate to the millimetre, ranging **from 40-60 cm (single door) or 80-100 cm (double door)**. **Unit heights of 50-250 cm** can also be flexibly implemented.

In addition, a **standard height of 93 cm for the floor unit and 119 cm for the tall unit** have been added: our VERO glass display cabinets are therefore available in all standard heights for floor, wall and tall units.

NICHE SHELF



NEW IN THE NICHE

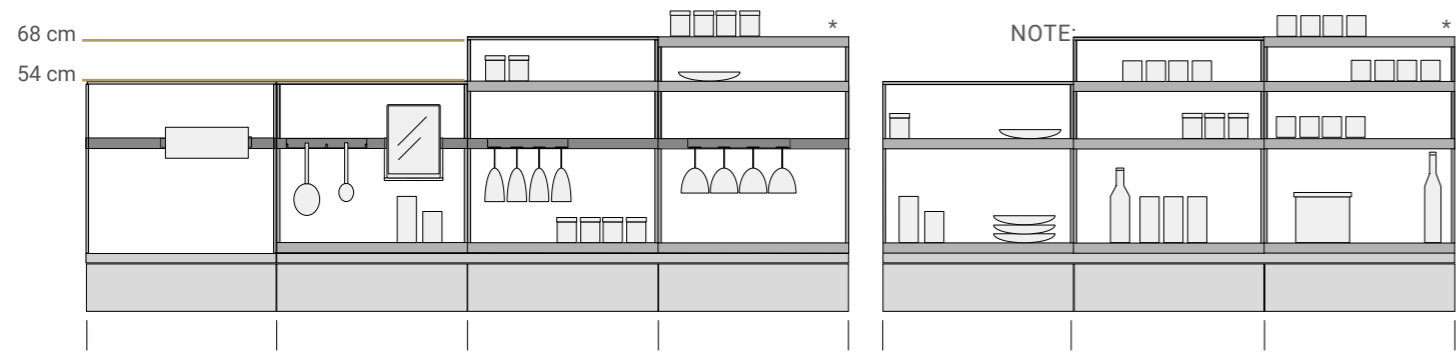

NRSM R Niche railing	NRSM...54 R Niche shelf unit with railing	NRSM...68 R Niche shelf unit with shelves and railing	NRSM...68 XL R Niche shelf unit with shelves and railing	NRSM...54 Niche shelf unit with shelves	NRSM...68 Niche shelf unit with shelves	NRSM...68 XL Niche shelf unit with shelves
1 x railing	1 x shelf 1 x railing	2 x shelves 1 x railing	3 x shelves 1 x railing	2 x shelves	3 x shelves	4 x shelves
	Height: 54 cm	Height: 68 cm	Height: 68 XL cm	Height: 54 cm	Height: 68 cm	Height: 68 XL cm
Accessories: NRSM PH Paper roll holder	Accessories: NRSM HL Hook bar NRSM TH Tablet holder	Accessories: NRSM SGH Champagne glass holder	Accessories: NRSM WGH Wine glass holder			

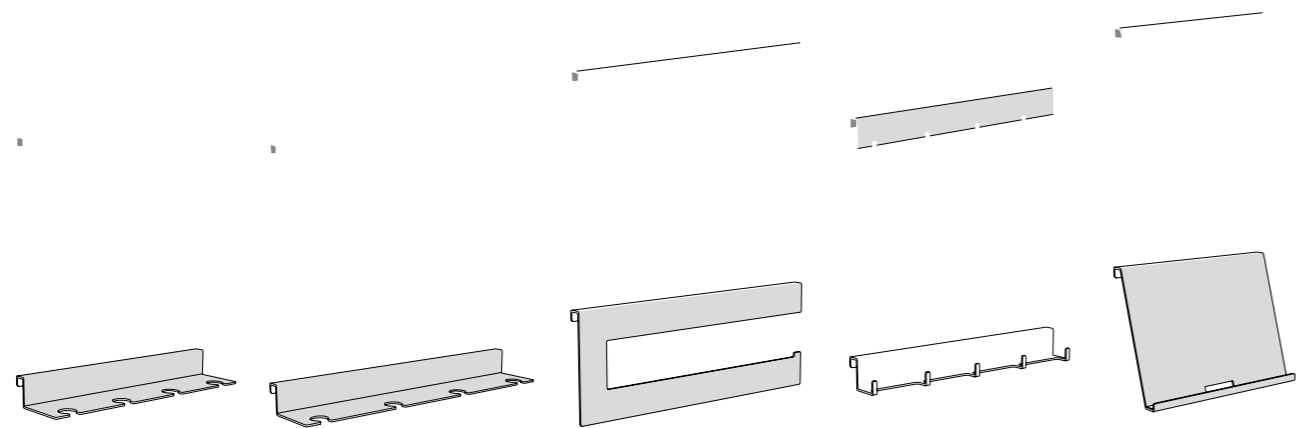

Champagne glass holder
NRSM SGH
+ for 4 glasses
27.5 cm long

Wine glass holder
NRSM WGH
+ for 4 glasses
35 cm long

Paper roll holder
NRSM PH
31.5 cm long

Hook bar
NRSM HL
+ with 5 hooks
27.5 cm long



WORKTOP EXTENSION



K 464 – alba serena

Five new colours are being added to our compact worktop range – from calm and elegant to authentic natural stone looks and modern metal reproductions with character.

K 288 – basaltino
K 289 – dolomita
K 464 – alba serena
K 471 – grigio velluto
K 472 – acciaio inox

These decors impress with their modern material appearance, authentic feel and high durability – perfect for kitchens with architectural appeal.

Our decor portfolio of laminate worktops is also being expanded to include the following striking and contemporary colours – naturally including matching worktop edge colours:

K 289 – dolomita
K 450 – pietra serena
K 451 – botticino terrazzo
K 457 – turco argento
K 462 – nero portoro
K 464 – alba serena
K 471 – grigio velluto
KM 126 – cashmere

These new decors offer versatile design options ranging from calm and elegant to striking with a natural stone character.



K 472 – acciaio inox

Worktops

Compact worktop

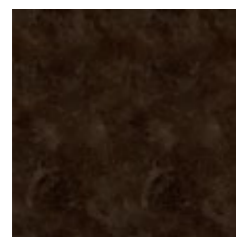

trentino
porphy

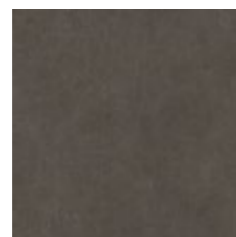

pietra serena

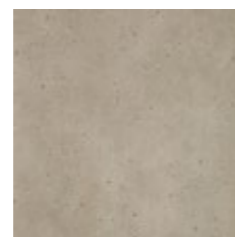

botticino
terrazzo

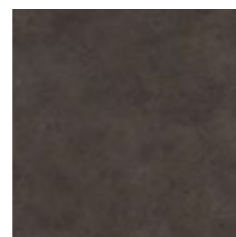

ouro preto

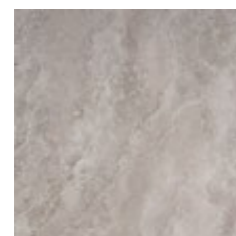

turco argento

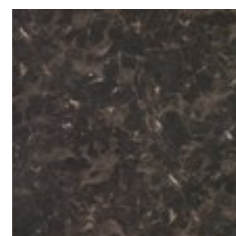

nero portoro



dark concrete

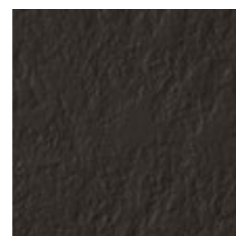

corvo



basaltino
NEW



dolomita
NEW

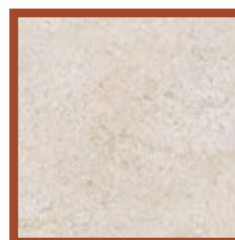

alba serena
NEW

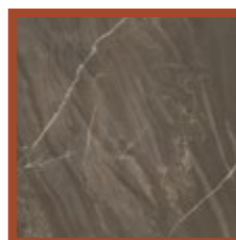

grigio velluto
NEW



acciaio inox
NEW



K 288 basaltino



K 289 dolomita

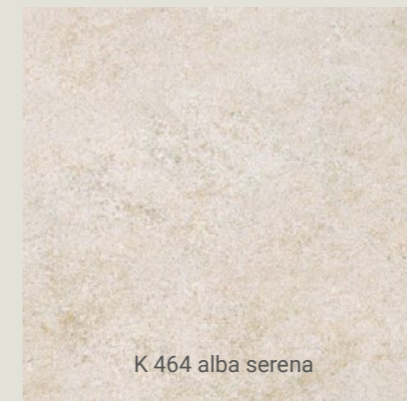

K 464 alba serena



K 471 grigio velluto



K 472 acciaio inox



kiruna

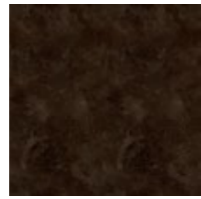

trentino porphy



keraton



liton



carboton



neroton

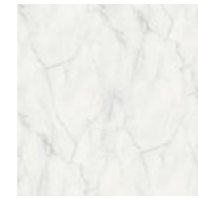

marmo venato

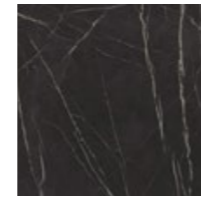

marmonero



dark concrete

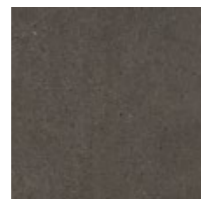

basaltino

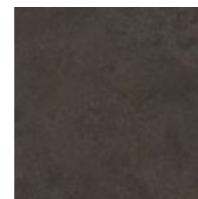

ouro preto

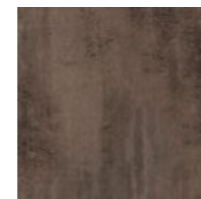

oxide brown



dolomita
NEW



turco argento
NEW

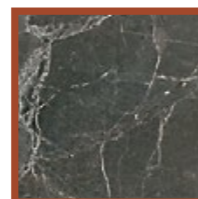

nero portoro
NEW

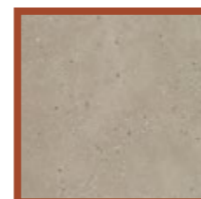

botticino terrazzo
NEW

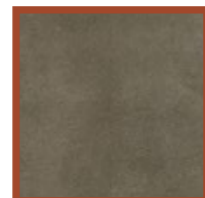

pietra serena
NEW

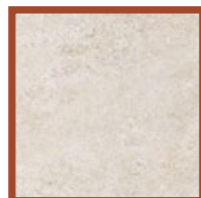

alba serena
NEW



cashmere
NEW

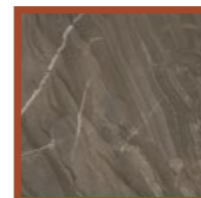

grigio velluto
NEW



K 289 dolomita



K 457 turco argento

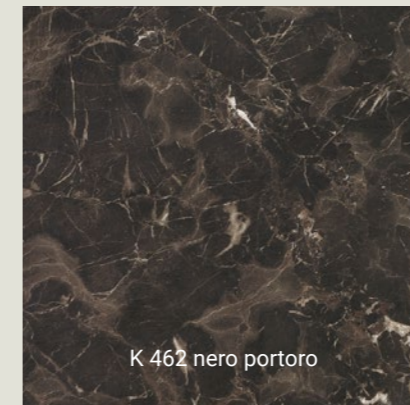

K 462 nero portoro



K 451 botticino terrazzo

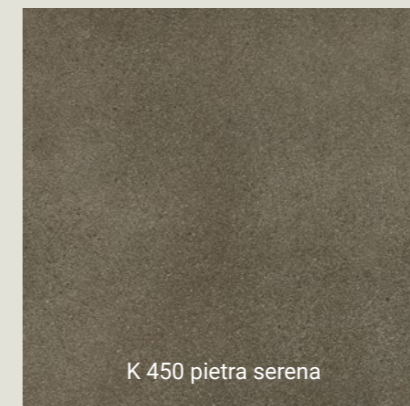

K 450 pietra serena

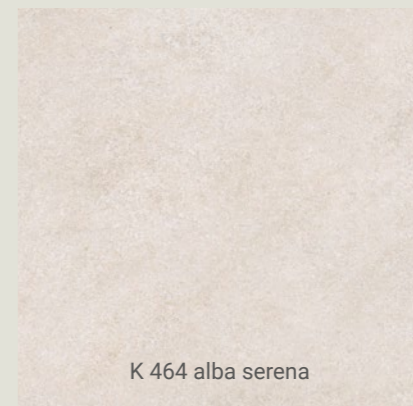

K 464 alba serena

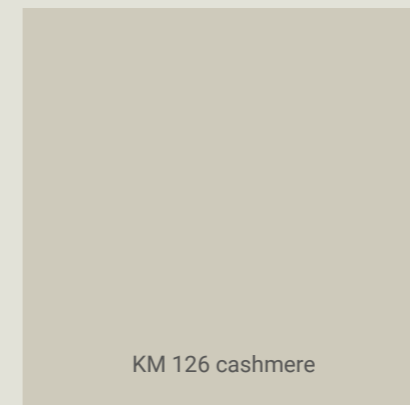

KM 126 cashmere

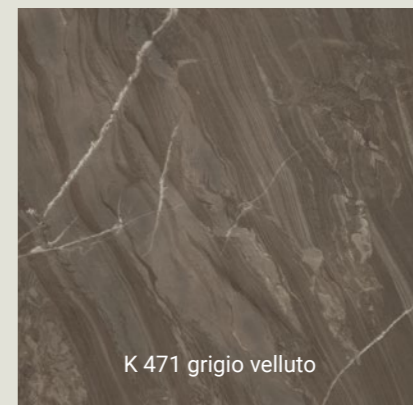

K 471 grigio velluto

SINKS



FRANKE

The colour coffee is a subtle shade of beige that goes very well with our light colour worktops.

Sinks:
FRANKE MRG*
FRANKE UBG*
FRANKE CNG*
FRANKE KNG*



SUTER

Sinks:
SUTER Daneo DAN 34F/7
SUTER Daneo DAN 40F/7
SUTER Daneo DAN 45F/7
SUTER Daneo DAN 50F/7

SPECIAL FEATURE:

- Only 7 mm visible edge and 1.5 cm radius
- Flush-surface fitting
- Tipo Desino drainage: manually operable
- TouchFlow Desino drainage: with touch control on the overflow

Tipo



TouchFlow



Tipo Desino



SUTER

Sinks:
SUTER Linero LIO 34F/7
SUTER Linero LIO 40F/7
SUTER Linero LIO 45F/7
SUTER Linero LIO 50F/7

SPECIAL FEATURE:

- Only 7 mm visible edge and 2.2 cm radius
- Flush-surface fitting
- Tipo Desino drainage: manually operable
- TouchFlow Desino drainage: with touch control on the overflow

HANDLES



Metal bow handle

stainless steel 411.418 411.405
 rose bronze 412.XXX powder
 coated Handle position: A, B, D



Metal bar handle

stainless steel 635.418 635.405
 rose bronze 636.XXX powder
 coated Handle position: B



Metal knob

cast iron Handle 170.414
 position: A, D



Grip profile

stainless steel 571.xxx powder 570.405
 coated Handle position: D

Grip profile

stainless steel 663.xxx powder 662.405
 coated Handle position: A

Form grip rail WAKUU

bronze dark 590.417 steel black 590.416
 Handle position: D

